

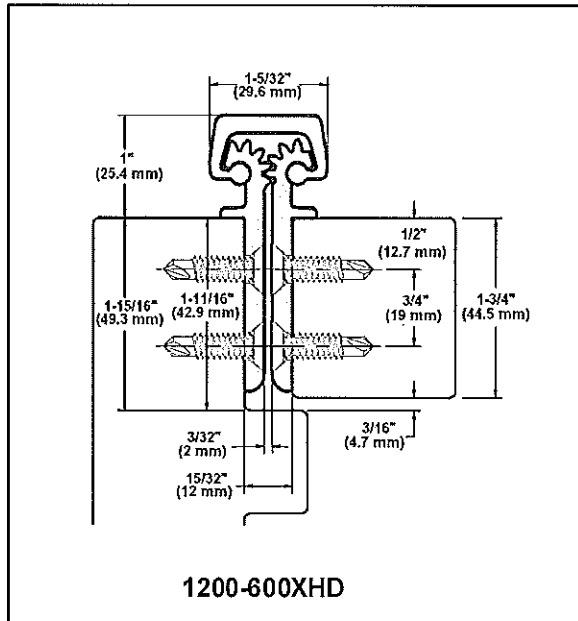

ROTON INSTRUCTION SHEET
ROTON MODEL:
1200-600XHD AND 1200-650XHD
 HAGER Companies - 139 Victor Street - St. Louis, MO 63104 | (800)-325-9995

PART NO: 75009480
 REVISION: 021510



1200-600XHD

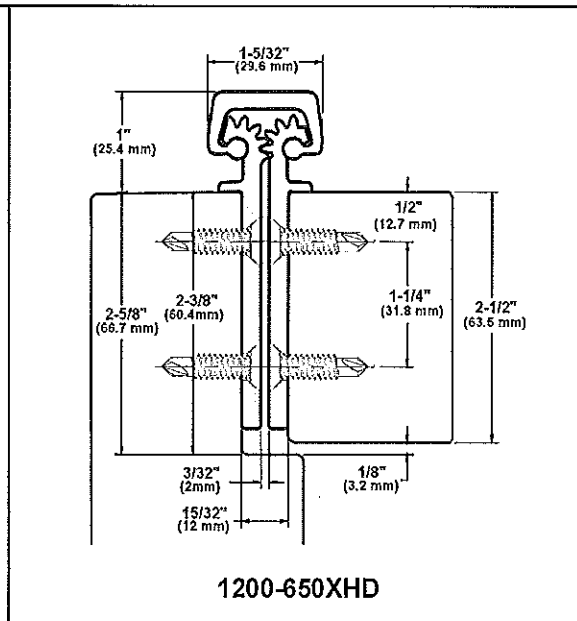

1200-650XHD

HAGER ROTON Models 1200-600XHD and 1200-650XHD are extra heavy-duty aluminum continuous geared concealed leaf hinges. Minimum clearance required between the hinge edge of the door and the frame is 15/32" (11.9mm). Model 1200-600XHD is for doors measuring from 1-3/4" to 2-1/4" thick and model 1200-650XHD is for doors 2-3/8" thick or greater.

Hinge Length

All ROTON Hinges are supplied approximately 1" to 1-5/16" shorter than the nominal door height to avoid threshold or carpet clearance problems. If the hinge must be trimmed shorter, first determine the correct hand of the door and orientation of the hinge. Then mark and trim from the *bottom* of the hinge only – do not cut from the top end.

NOMINAL DOOR HEIGHT	ACTUAL HINGE LENGTH	NUMBER OF FASTENERS (Door Leaf / Frame Leaf)
7'-0"	83" (2108mm)	26 / 26
8'-0"	95" (2413mm)	28 / 28
10'-0"	119" (3022mm)	33 / 33

Clearance Required Between Door and Frame

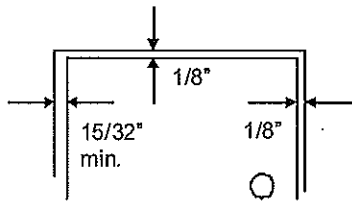

SINGLE DOOR - SQUARE EDGED*

Hinge thickness	15/32" (11.9mm)
Allowance for frame irregularities	1/32" (0.8mm)
Latch side clearance	1/8" (3.2mm)
Total*	5/8" (15.9mm)

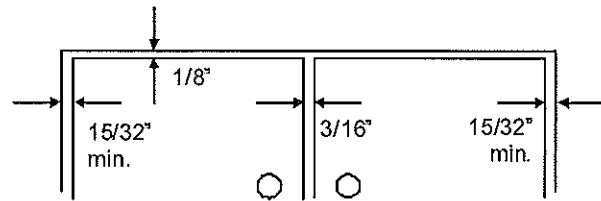

PAIR OF DOORS - SQUARE EDGED*

Hinge thickness	15/32" (11.9mm)
Allowance for frame irregularities	1/32" (0.8mm)
Clearance between doors (recommended)	3/16" (4.8mm)
Second allowance for frame irregularities	1/32" (0.8mm)
Second hinge thickness	15/32" (11.9mm)
Total*	1-3/16" (30.2mm)

*For doors with a beveled edge on the hinge side allow an additional 1/32" clearance per door.

General Fitting Procedure

- For new construction with metal doors/frames: To accommodate the 15/32" (11.9mm) hinge clearance required for HAGER ROTON models 1200-600XHD and 1200-650XHD, order the door undersized or the frame header oversized. See the clearance information above to attain the proper size. Mortar guards, either styrofoam or wood, are recommended for frames to prevent grout from interfering with the installation of the hinge fasteners.

For new site-hung wood doors: If necessary, scribe and cut from the *latch edge* of the door to leave sufficient hinge stile thickness for proper fastening. A minimum clearance of 15/32" (11.9mm) is required between the hinge edge of the door and the frame rabbet. See the clearance information above to attain the proper finished width of the door.



ROTON INSTRUCTION SHEET
ROTON MODEL:
1200-600XHD AND 1200-650XHD

HAGER Companies - 139 Victor Street - St. Louis, MO 63104 1(800)-325-9995

PART NO: 75009480
REVISION: 021510

- For remodeling with existing wood or laminate doors: If necessary, scribe and cut from the hinge edge of the door and plane smooth. A minimum clearance of 15/32" (11.9mm) is required between the hinge edge of the door and the frame rabbet. See the clearance information above to attain the proper finished width of the door.

Installation Procedure

Frame Preparation

- With the hinge open, place the frame leaf against the frame making certain that the alignment rib is flush against the face of the frame along its entire length. Position the top of the hinge 1/16" (1.6mm)(1/8"maximum) below the header. **Note: A 1/16" shim is recommended due to initial settling of the bearings.** (See Fig. 1)
- Mark and center punch the screw hole locations. Accurate location is important for proper hinge installation.
- For wood frames, drill pilot holes using a 13/64" (5.2mm) bit for optional 1/4" wood screws. For fiberglass frames, drill pilot holes using a 7/32" (5.5mm) bit. For metal frames, pre-drilled pilot holes are not necessary if using the self-drilling screws provided.
- Do not attach the hinge to the frame at this time.

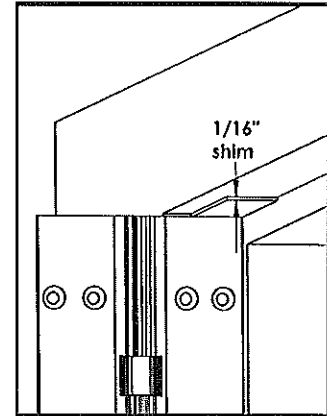

Fig. 1

Door Preparation

- With the hinge open, place the door leaf against the edge of the door making certain that the door alignment rib is flush against the face of the door along its entire length. Position the top of the hinge flush with the top of the door.
- Mark and center punch the screw hole locations. Accurate location is important for proper hinge installation.
- For wood doors, drill pilot holes using a 13/64" (5.2mm) bit for optional 1/4" wood screws. For fiberglass doors, drill pilot holes using a 7/32" (5.5mm) bit. For metal doors, pre-drilled pilot holes are not necessary if using the self-drilling screws provided.
- Attach the hinge to the door. For wood or fiberglass doors, use the 1/4" x 1-1/2" optional wood screws. For metal doors, use the 1/4"-20 x 1" self-drilling screws provided (recommended driver speed 1,900-2,500rpm).

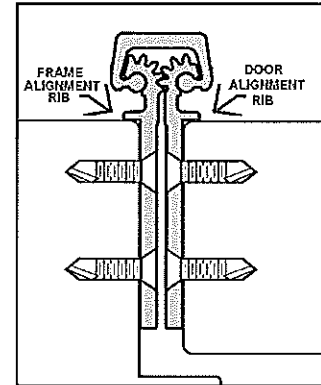

Fig. 2

Hanging the Door

- Position the door (with hinge attached) at 90° to the frame. Attach the hinge to the frame (see fig.3). For wood or fiberglass frames, use the 1/4" x 1-1/2" optional wood screws. For metal frames, use the 1/4"-20 x 1" self-drilling screws provided (recommended driver speed 1,900-2,500rpm).
- Make a gently trial swing. Carefully check the door for proper swing and clearance.

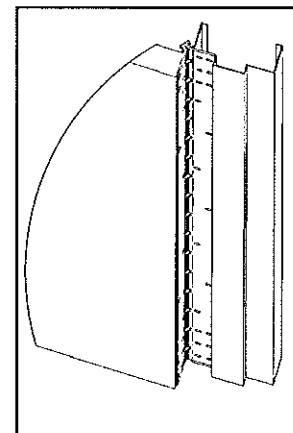
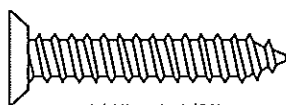

Fig. 3

Adjusting the Door

- If lateral adjustment is required because of excessive or uneven frame clearance, adjust by shimming where needed.
 - For minor adjustment an effective shimming material is 1-1/2" strips of cloth duct tape. Apply tape to the frame underneath the frame leaf in stepped layers to build up to the desired thickness.
 - To shift the entire door, a thin continuous aluminum strip may be used under the frame leaf (available in 1/16" and 1/8" thicknesses from hager).
- Retighten all screws. Carefully check the door for proper swing and clearance.



1/4" x 1-1/2"
Wood Screw
(Optional)



1/4"-20 x 1"
Self-Drilling Screw