

### Verbal Exit Instructions or Alarm Tone Only and Digital Countdown Display

- Stop Employee Theft
- Stop Retail Shoplifting
- Restrict Airport Patrons
- Restrict Wandering Patients

The integral verbal message, digital countdown display and sign provide comprehensive and clear instructions of the door operation for persons without prior knowledge of the exit delay, including the sight and hearing impaired.

The digital keypad eliminates the need to carry and locate keys for reset and bypass functions.

### Features:

#### Egress Delay

- 15 or 30 second exit delay
- 1 or 2 second nuisance delay

#### Built-In 3 Function keypad

- Alarm and lock reset
- 1 to 30 second bypass
- Sustained bypass
- Additional keyswitch optional

#### Control Inputs

- 1 to 30 second request-to-exit and bypass input with anti-tailgate and jumper selectable door prop alarm.
- Reset

#### Trigger Modes

- Egress alarm triggered by Push Bar
- Trigger input from external device field selectable (N/O or N/C)

#### Code Compliance

- IFC International fire Code
- IBC International Building Code
- NFPA 101 Life Safety Code
- NFPA 1 Uniform Fire Code
- California Building Code
- Field selectable automatic or manual power up after emergency release or power loss. Use of manual power up complies with California Building Code (OSHPD) requirements.

2-679-0630  
WALL CONTROLLER



4500/4600  
RIM MOUNT OR  
VERTICAL ROD\*  
EXIT DEVICES

### Application:

When unauthorized egress is initiated 4500 DE delays egress through the door for 15 seconds (or 30 seconds). Meanwhile, the person exiting must wait while personnel or security responds. The door unlocks after 15 seconds have elapsed permitting egress. When powered by a fire control supervised power supply, the lock will release immediately in an emergency.

\* **Note:** If being used with a Surface Vertical Rod Exit Device, rod covers are required for security.

### Built-In Annunciation

- Armed mode
- Nuisance mode
- Irreversible egress mode
- Release mode
- Digital countdown mode
- Field selectable voice notification or tone
- Field selectable male voice with security message or female voice with safety message

### Monitoring Outputs

- Armed mode
- Egress initiation status
- Released status

### Choice of Mounting

- Recessed mounted (3 gang metal plaster ring included)
- Surface mounted with optional 3 gang box (2-679-0641)
- Optional shroud (2-679-0642) to be used with (2-679-0641) surface box.

SYSTEM SPECIFICATIONS	
INPUT VOLTAGE	INPUT VOLTAGE
MAX CURRENT DRAW (SINGLE)	430mA @ 24 VDC
(TANDEM)	680mA @ 24 VDC
MONITOR RELAYS CONTACT RATING	1 AMP @ 12/24 VDC (RESISTIVE)
TEMPERATURE	0°C - 70°C

**NOTE: Hager 2908 Power Supply required**

## KEY CYLINDER INSTALLATION

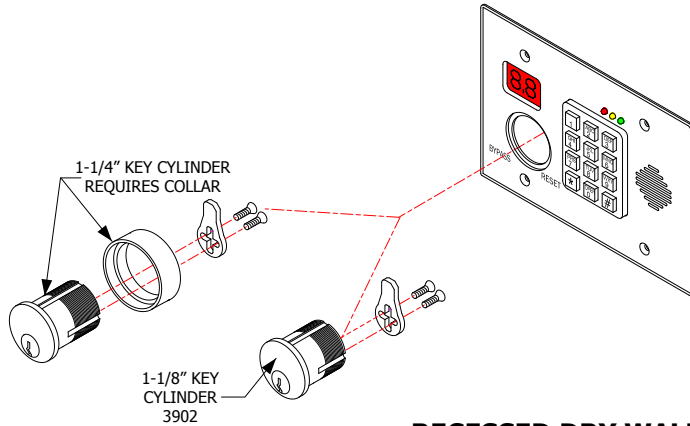

WITH KEY CYLINDER IN PROPER POSITION INSIDE SWITCH BLOCK, TIGHTEN THE SET SCREW TO LOCK CYLINDER IN PLACE.

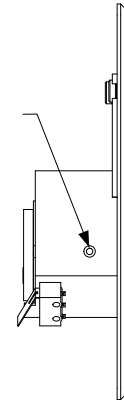

## RECESSED DRY WALL MOUNTING

- 1) Cut hole in dry wall to dimensions shown.
- 2) Mount wall bracket over hole.
- 3) Carefully insert unit and secure with screws supplied.

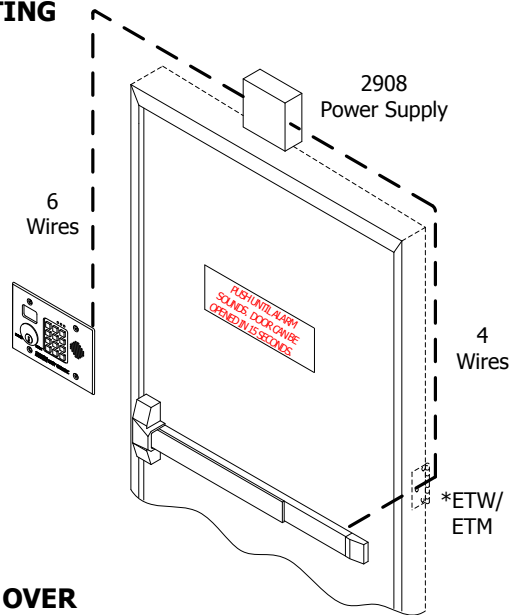
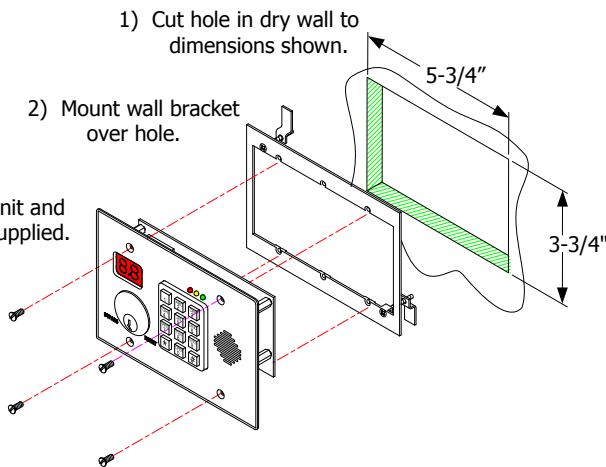

## SURFACE MOUNT 3 GANG BOX OVER EXISTING RECESSED 2 GANG BOX

- 2) Carefully insert unit and secure with screws supplied.

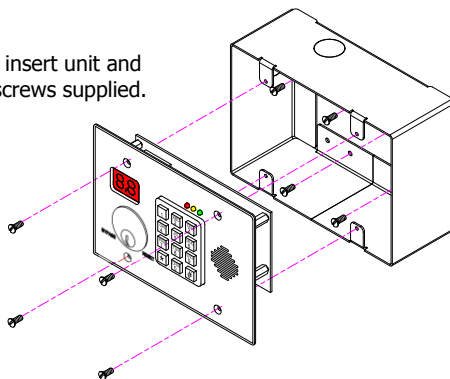

- 1) Attach optional 3 Gang Surface Mount Box to existing recessed 2 gang box using screws supplied.

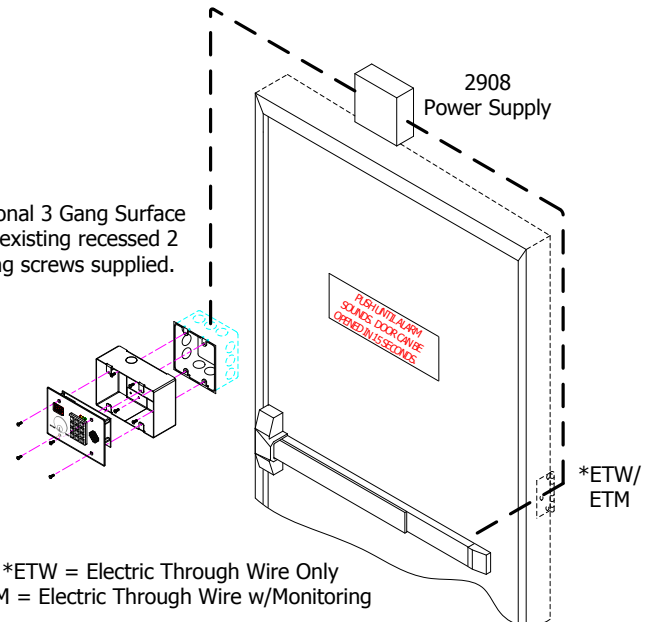

\*ETW = Electric Through Wire Only  
ETM = Electric Through Wire w/Monitoring

**RECOMMENDED MOUNTING PROCEDURE**

USE 1-1/4" SCREWS SUPPLIED WITH WALL MOUNT FRAME TO HANG UNIT TEMPORARILY FOR WIRING PURPOSES

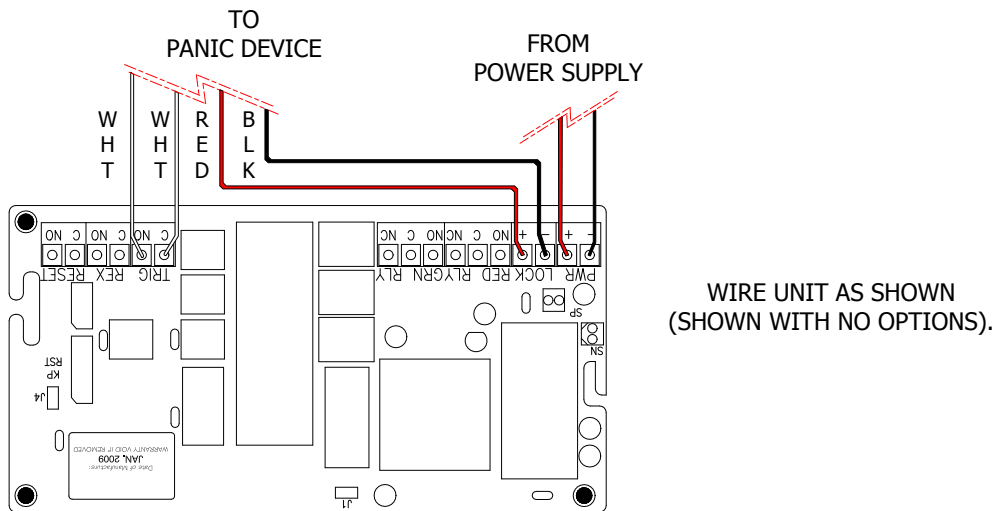
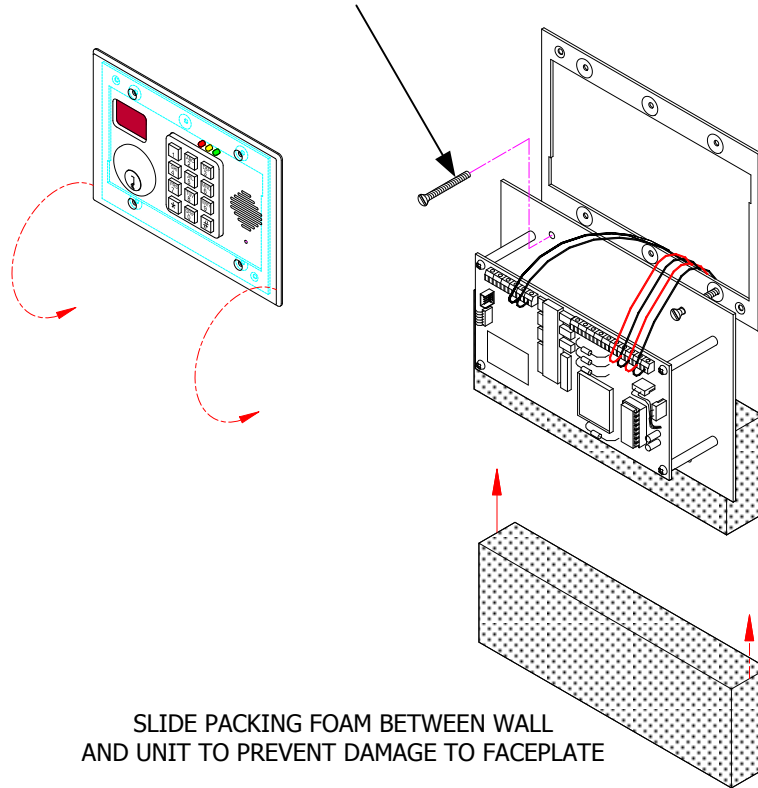

**Wiring Diagrams and Options**

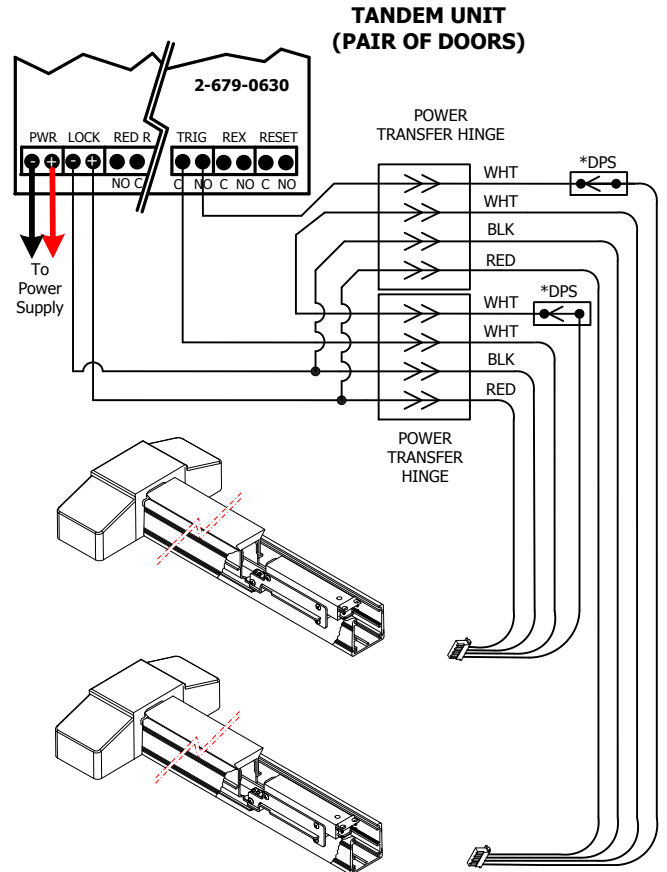
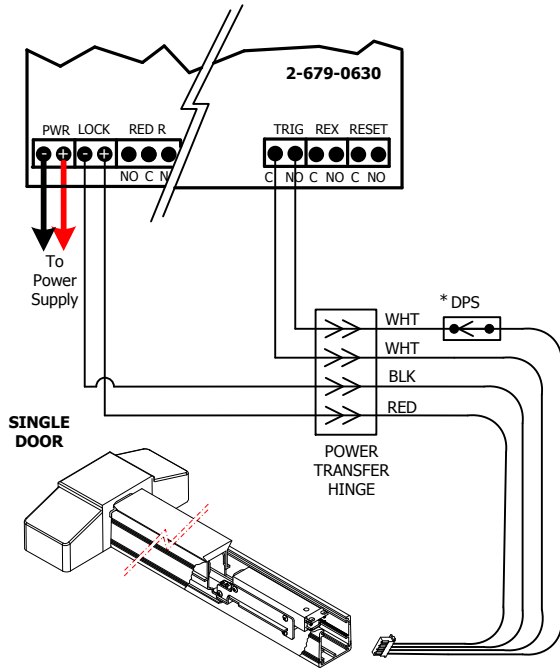

**\*\*JUMPER J1 (DOOR PROP)**

**INSTALLED:** The 4500 DE will enter the alarm mode if the door is held open past the request to exit period.

**REMOVED:** The 4500 DE will remain unlocked if the door is held open past the request to exit period. No alarm will sound.

For the 4500 DE to relock and rearm upon closure of the door, DPS is required.

\*Door Contact or Power Transfer Hinge by DPS required for Anti-Tailgate and Door Prop operation.

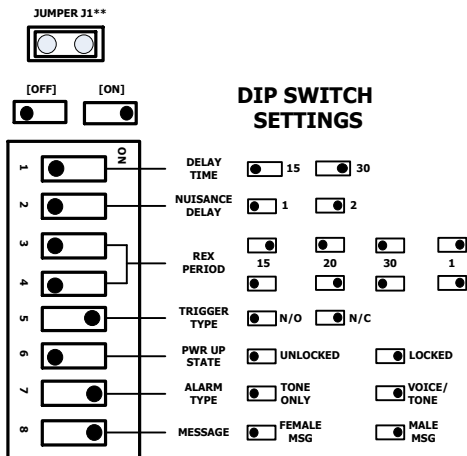

**WARNING!**  
CONTACT THE AUTHORITY HAVING JURISDICTION FOR APPROVAL  
PRIOR TO SELECTING DELAY TIME OR PWR-UP SETTINGS

**Optional Features**

**External Request to Exit:** The REX TERMINAL is a wet 12/24VDC output to be used with a keypad such as a 2915.

**External Reset:** The RESET TERMINAL is a wet 12/24VDC output to be used with a keypad such as a 2915.

**Lock/Unlock Monitoring:** The GRN RLY TERMINAL is a dry relay that is activated when the LOCK output is activated.

**Alarm Monitoring:** The RED RLY TERMINAL is a dry relay that is activated when the Alarm is activated.

### System Operation



#### POWER-UP UNLOCKED

 The door is unlocked. To enter the Armed Mode, turn the keyswitch to Reset or enter the Reset Code "11\*" on the keypad

#### POWER-UP LOCKED

 The door is locked and secure

#### DELAYED EGRESS MODE

 →  →  The door is still locked and secure. The display is counting down with audible alarm/voice instructions. Once the display reaches "00", the door will unlock.

#### ALARMED UNLOCKED [Alternating Display]

 The door is unlocked and the alarm is sounding. To return to Armed Mode, close the door and turn the key to Reset or enter the Reset Code "11\*" on the keypad

 The door is unlocked and has been opened

#### RESET [Armed] (Green LED solid)

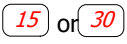
 The door is locked and secure

#### Keypad Code 11\*

#### AUTHORIZED EGRESS [REX] (Green LED Solid)

 Door Closed      The door is unlocked until the REX timer has expired or until the door has been opened and then closed.

 Door has been opened

#### Keypad Code 22\*

#### BYPASS [Extended Unlock] (Green LED Flashing)

 Door Closed      The door is unlocked indefinitely. To return to Armed Mode, turn the keyswitch to Reset or enter the Reset Code "11\*" on the keypad.

 Door has been opened

#### Keypad Code 33\*

### Returning the Keypad to Factory Default Settings

Short the **KP RST** terminal located on the main controller board.

Press 99# 1234\*8#\* to enter programming mode and erase all users.

Press 3#1#2#\*. Sets the Output #1 (Reset) for 2 seconds.

Press 3#2#2#\*. Sets the Output #2 (Auth Exit) for 2 seconds.

Press 3#3#0#\*. Sets the Output #3 (Bypass) for latching.

Press 1#02#11#2#\*. Adds user # 2 with a code of 11\*. [Reset]

Press 1#03#22#3#\*. Adds user # 3 with a code of 22\*. [Auth Exit]

Press 1#04#33#4#\*. Adds user # 4 with a code of 33\*. [Bypass]

Press \*\* to exit programming mode.

Remove the shorting jumper from the **KP RST** terminal.

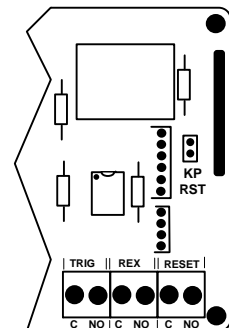

## Keypad Programming

### KEYPAD STATUS LEDS

**GREEN**

Steady: Power on, No errors, No outputs are active  
Slow Flash: No errors, At least one output is active

**RED**

Steady: General error, invalid code entered  
Slow Flash: Error condition: At least one output is active

**YELLOW**

Slow Flash: Keypad is in Programming Mode  
Single Flash: For ADA requirements, it will light each time a key is pressed

### FACTORY PROGRAMMED CODES

User No.	Pin Code	Output Code	Function
1	1234*	NA	Master Code (default)
2	11*	2	Reset
3	22*	3	Authorized Exit (Rex)
4	33*	4	Bypass (toggle on)

If the factory programmed codes are acceptable for your installation, no additional programming is required.

### Entering and Exiting Programming Mode

Press 99# Master Code \* to enter programming mode.

*For example: 99# 1234\* Enters programming mode using the Default Master Code.*

Press \*\* to exit programming mode.

### Changing the Master Code

User 1 is always used as the Master Code and is required to access keypad programming. The Factory Default Master Code is "1234 ". It is strongly recommended that a new Master Code is assigned after installation. **WRITE DOWN THE NEW CODE.**

If the master code is lost, you must use the keypad reset jumper on the main circuit board to enter programming mode by using the Default Master Code (See Page 5).

To Change the Master Code (User 1)

- 1) Enter Programming Mode.
- 2) Assign new Master Code : Press 1# 01# New Pin Code# Output Code #\* .  
*For example: 99# 1234\*1# 01# 3871# 0#\* changes the Master code from 1234 to 3871.*
- 3) \*Exit programming mode.

### Adding a User / Changing User Pin Codes (Option 1)

To add a user:

- 1) Enter Programming Mode.
- 2) Press 1# User Number (2 digits)# New Pin Code# Output Code #\* .  
*For example: 99# 1234\*1# 05# 55# 2#\* adds user 5's pin code (55) as one that will activate authorized exit.*
- 3) \*Exit Programming Mode.

### Deleting a User (Option 2)

To delete a user:

- 1) Enter Programming mode.
- 2) Press 2# User Number (2 digits)#\* .  
*For example: 99# 1234\* 2# 05#\* deletes user 5.*
- 3) \*Exit Programming mode.

### Erase All Users (Option 8)

To **ERASE ALL USERS!!**

- 1) Enter Programming Mode.
- 2) Press 8#\* .
- 3) \*Exit Programming Model  
*All users are erased and the Default Master Code is reset to 1234.*

\*Multiple options may be performed without exiting programming mode.

**Recommended Programming Steps**

- 1) Test the controller to verify that all default codes are working as expected.
- 2) Record all desired users, names, and PIN codes in the table below.
- 3) Enter programming mode.
- 4) Delete all default users using the "Delete All Users" option on page 6.
- 5) Change the Master Code to the desired Master Code.
- 6) Exit programming mode.
- 7) Enter programming mode using the new Master Code to test it.
- 8) Add all users in the table below.
- 9) Test all users and verify for desired functionality.

<i>User Number</i>	<i>Name</i>	<i>PIN Code</i>	<i>User Number</i>	<i>Name</i>	<i>PIN Code</i>