

TEMPLATE FOR FULL MORTISE CONTINUOUS GEARED ALUMINUM HINGE

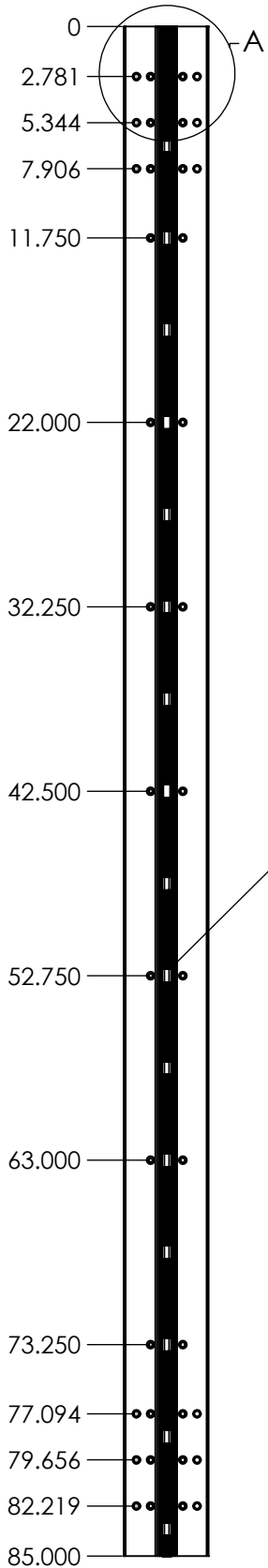

BEARINGS
16 PLACES

#12 FLAT HEAD SCREW
38 PLACES

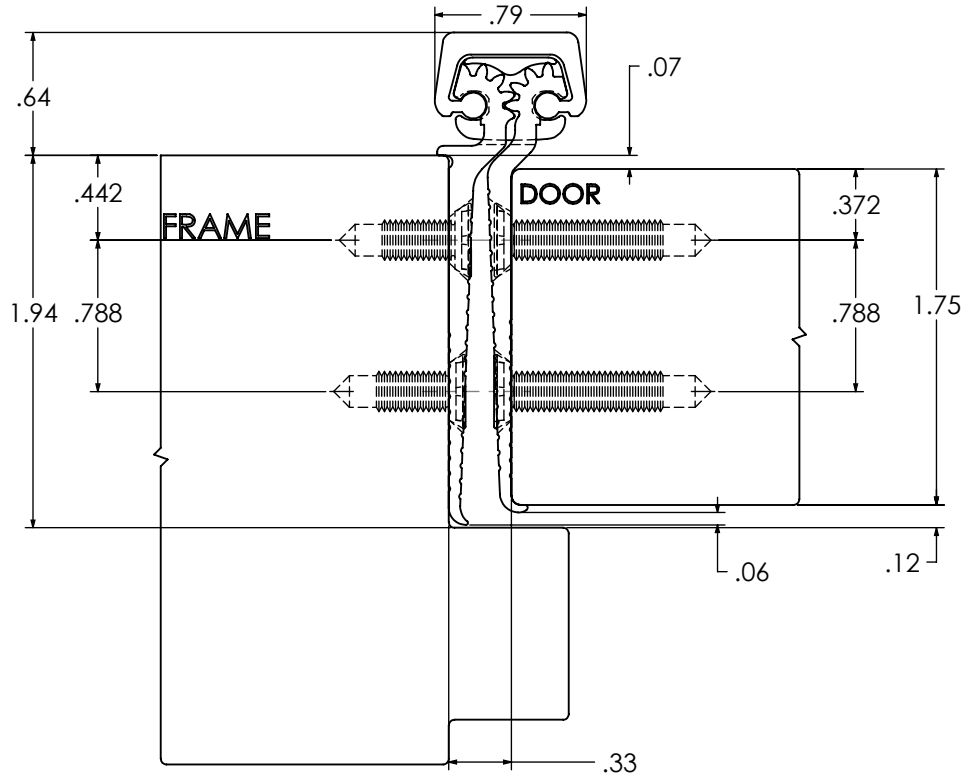

SCALE 1 : 1

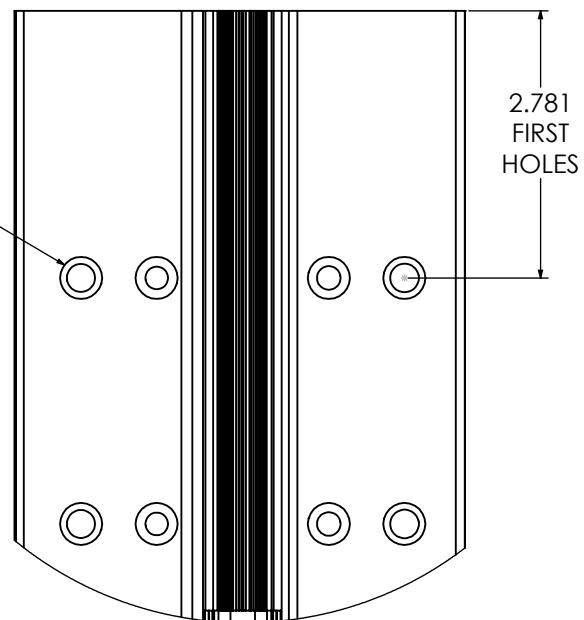

DETAIL A
SCALE 1 : 2