

TEMPLATE FOR FULL MORTISE CONTINUOUS GEARED ALUMINUM HINGE

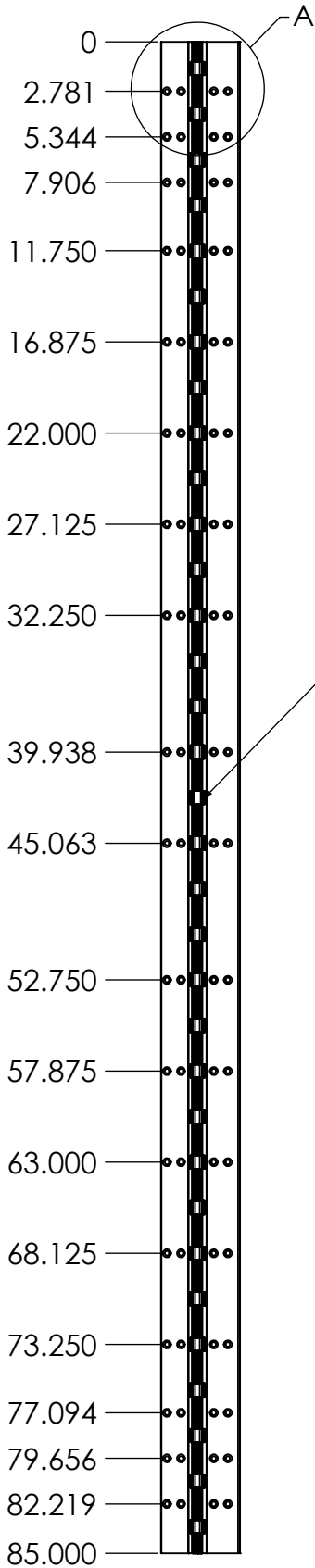

BEARINGS
33 PLACES

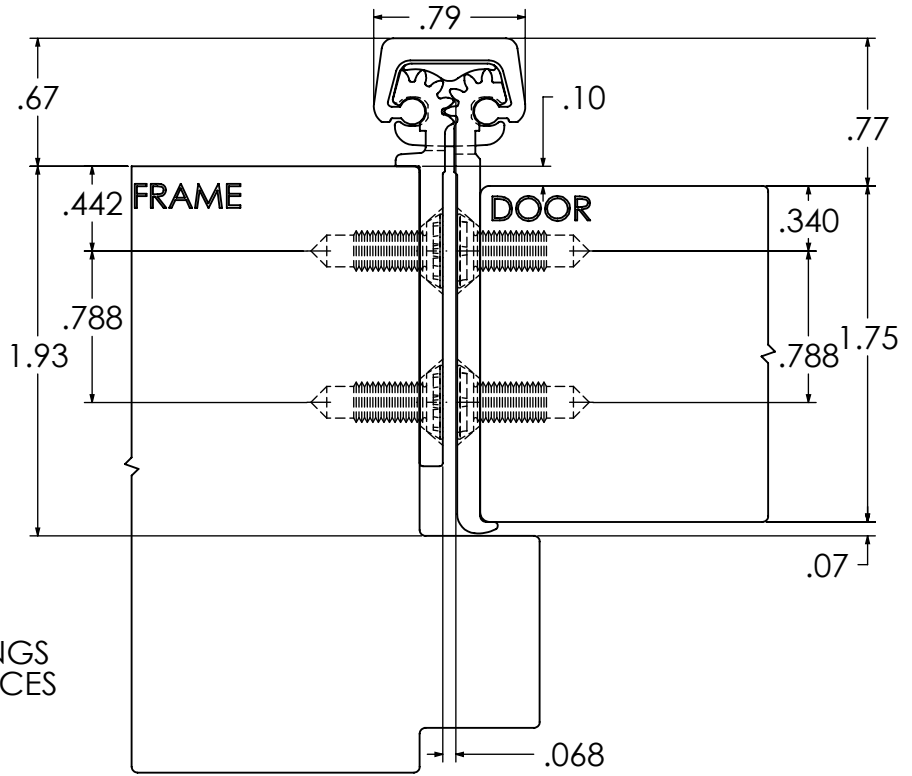

SCALE 1 : 1

#12 FLAT
HEAD SCREW
72 PLACES

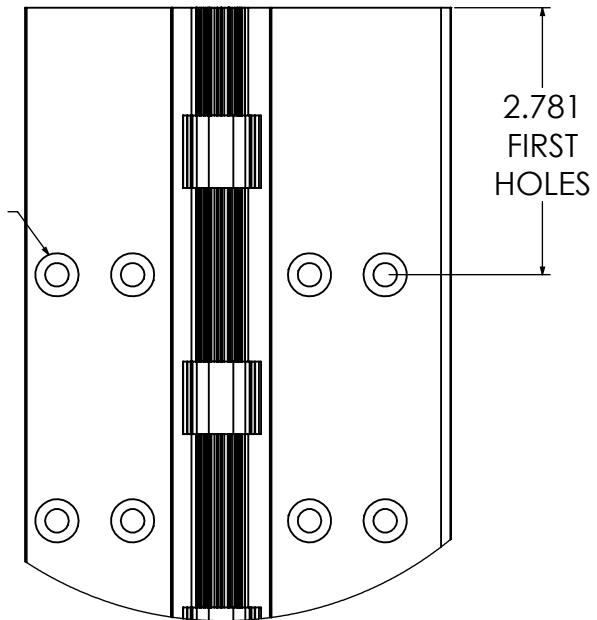

DETAIL A
SCALE 1 : 2